

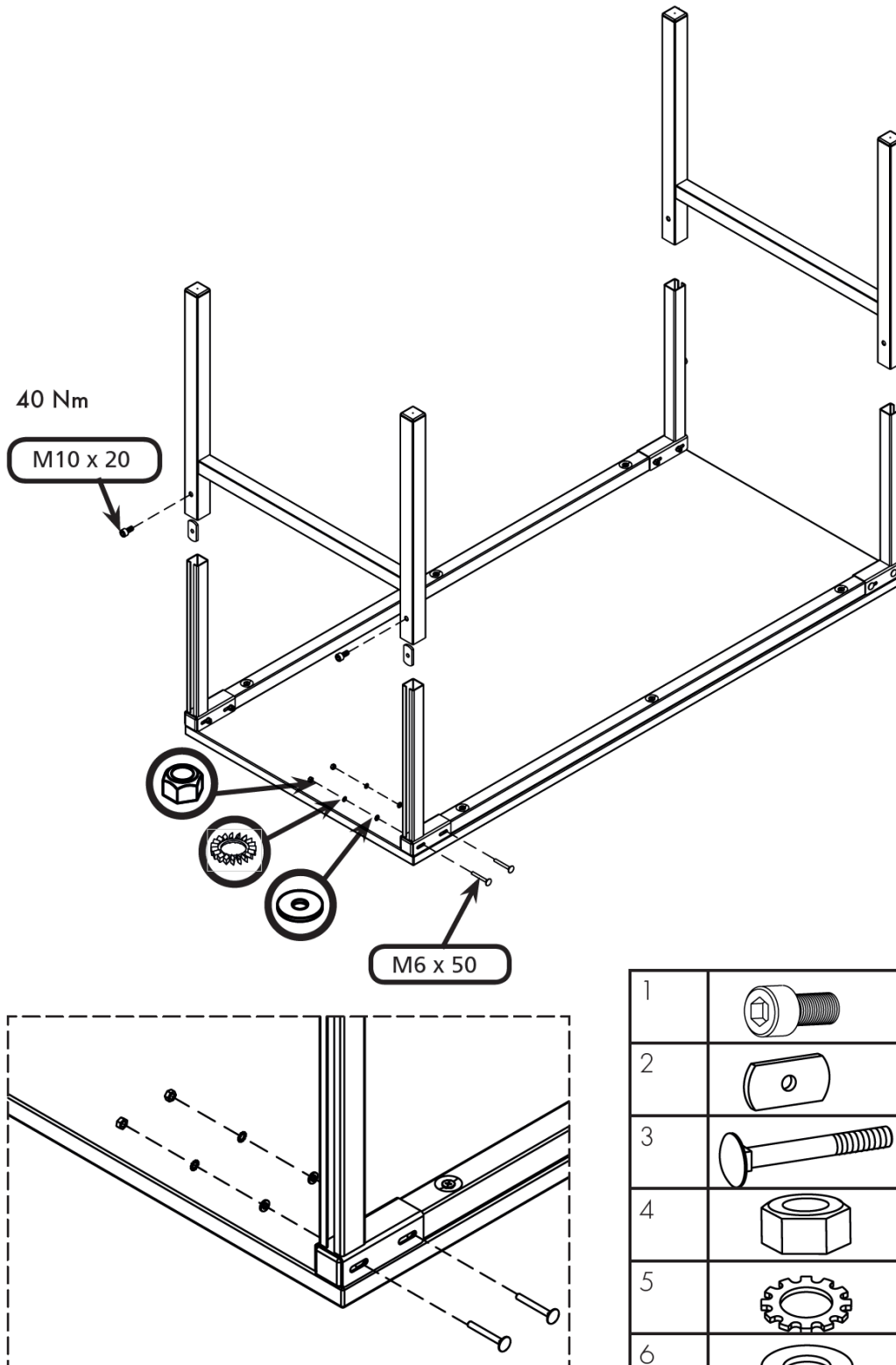

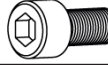



Reguleeritava kõrgusega TP-seeria töölaua ja TP-L seeria lisalaua komplekteerimisjuhend.



1		M10x20	4 x
2		M10	4 x
3		M6x50	8 x
4		M6	8 x
5		6,4	8 x
6		6,4	8 x

